

客户图

- NOTES:
- FINISH:
 - HOUSING: LCP BLACK,UL94V-0.
 - CONTACT: COPPER ALLOY, GOLD 10u" PLATED IN CONTACT AREA, 80u" MIN MATTE TIN PLATED OVER 50u" MIN. NICKEL UNDERPLATED OVER ALL.
 - ELECTRICAL:
 - RATED VOLTAGE: POWER PIN AC 575V
POWER PIN DC 812V.
 - CURRENT RATING: 2PC POWER PIN 28.8A.
4PCS POWER PIN 24.7A.
6PCS POWER PIN 24.1A.
8PCS POWER PIN 22.3A.
 - OPERATION TEMPERATURE: -55°C TO +125°C.

62S1-F XXX S4 101 C 01

Pin数码 端子电镀: 塑胶高度: 包装方式:
002=2PIN S4=10u" Gold/Tin 101=10.16mm C=TRAY
~ SN=TIN

TABLE1:

No. OF PIN	A	B	C	D
002=2PIN	16.28	10.18	5.00	6.88
003=3PIN	21.28	15.18	10.00	11.88
004=4PIN	26.28	20.18	15.00	16.88
005=5PIN	31.28	25.18	20.00	21.88
006=6PIN	36.28	30.18	25.00	26.88
007=7PIN	41.28	35.18	30.00	31.88
008=8PIN	46.28	40.18	35.00	36.88
009=9PIN	51.28	45.18	40.00	41.88
010=10PIN	56.28	50.18	45.00	46.88

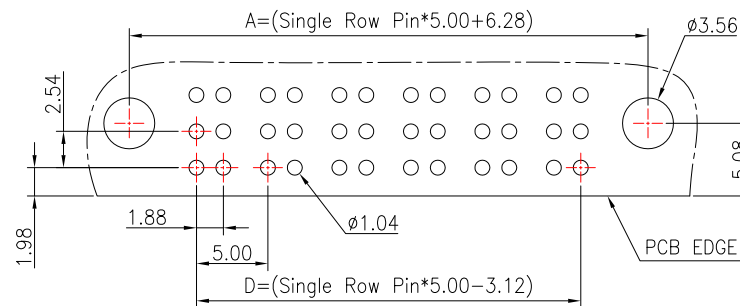
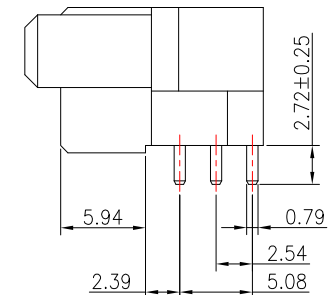
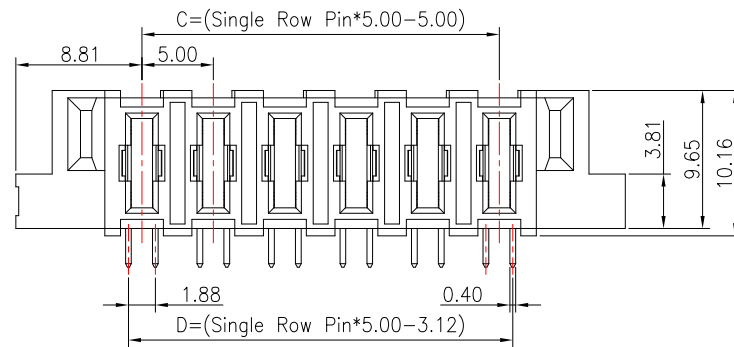
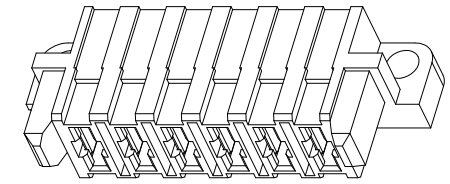
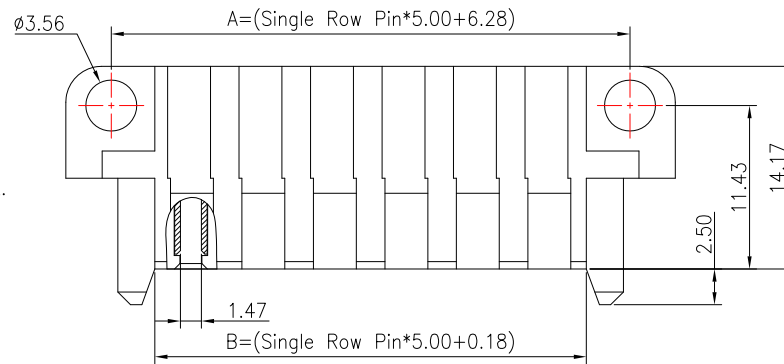

RECOMMENDED PCB LAYOUT
PCB BOARD TOLERANCE ±0.05

				OPERATION		DRAW		WLY		2021.12.25		SOLEPIN 东莞市硕品电子有限公司 Professional connector manufacturer DONGGUAN SOLEPIN ELECTRONICS CO., LTD.			
				X.X	±0.40	DESIGN	Jensen							SIZE	A4
				X.XX	±0.25	CHECK	Jack					SHEET	1/1	TITLE:	5.0mm 电源连接器 母座 DIP90° TYPE
AO		NEW		X.XXX	±0.15	APPROVE	Andy					PROJ.	PROJ.	DRAW NO.	SP-690
REV	DATE	MODIFICATION DESCRIPTION	CHANGE	APPROVE	DIM.	TOL	UNIT	mm	SCALE	1:1					

客户图

- NOTES:
- FINISH:
 - HOUSING: LCP BLACK,UL94V-0.
 - CONTACT: COPPER ALLOY, GOLD 10u" PLATED IN CONTACT AERA, 80u" MIN MATTE TIN PLATED OVER 50u" MIN. NICKEL UNDERPLATED OVER ALL.
 - ELECTRICAL:
 - RATED VOLTAGE: POWER PIN AC 575V
POWER PIN DC 812V.
 - CURRENT RATING: 2PC POWER PIN 28.8A.
4PCS POWER PIN 24.7A.
6PCS POWER PIN 24.1A.
8PCS POWER PIN 22.3A.
 - OPERATION TEMPERATURE: -55°C TO +125°C.

62S1-M XXX S4 124 C 01

Pin数码 端子电镀: 塑胶高度: 包装方式:
002=2PIN S4=10u" Gold/Tin 124=12.45mm C=TRAY
~ SN=TIN

TABLE1:

No. OF PIN	A	B	C	D
002=2PIN	16.28	17.55	5.00	6.88
003=3PIN	21.28	22.55	10.00	11.88
004=4PIN	26.28	27.55	15.00	16.88
005=5PIN	31.28	32.55	20.00	21.88
006=6PIN	36.28	37.55	25.00	26.88
007=7PIN	41.28	42.55	30.00	31.88
008=8PIN	46.28	47.55	35.00	36.88
009=9PIN	51.28	52.55	40.00	41.88
010=10PIN	56.28	57.55	45.00	46.88

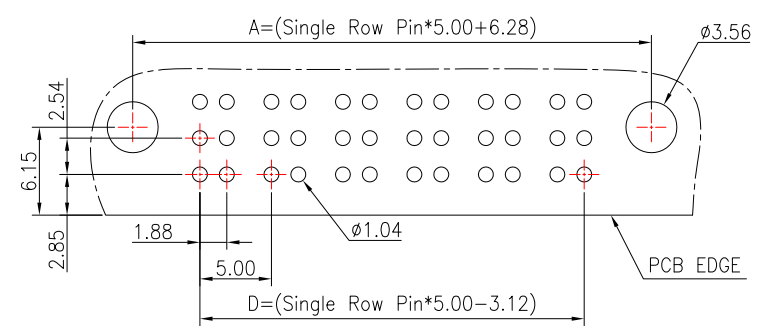
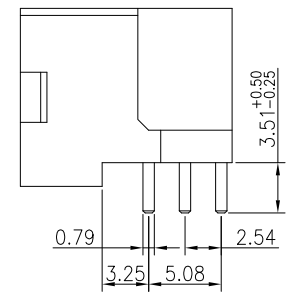
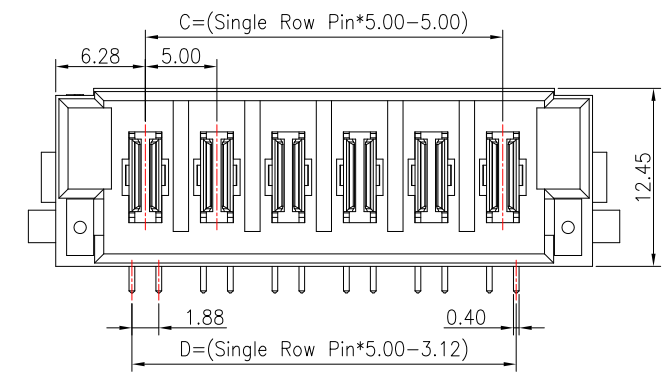
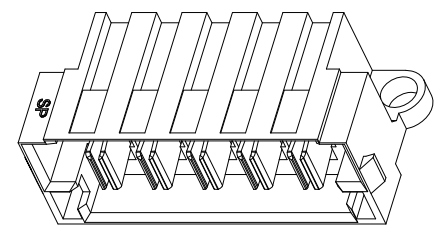
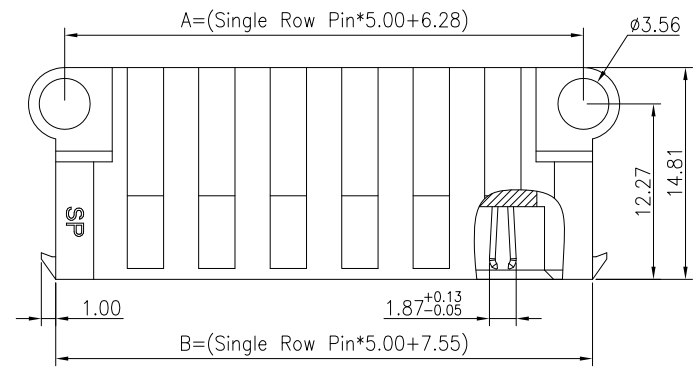

				OPERATION		DRAW		WLY		2021.12.25		SOLEPIN 东莞市硕品电子有限公司 Professional connector manufacturer DONGGUAN SOLEPIN ELECTRONICS CO., LTD.			
				X.X	± 0.40	DESIGN		Jensen		2021.12.25					
				X.XX	± 0.25	CHECK		Jack		2021.12.25		SHEET	1/1	TITLE:	5.0mm 电源连接器 公头 DIP90° TYPE
AO		NEW		X.XXX	± 0.15	APPROVE		Andy		2021.12.25		PROJ.		DRAW NO.	SP-073
REV	DATE	MODIFICATION DESCRIPTION		CHANGE	APPROVE	DIM.	TOL	UNIT	mm	SCALE	1:1				

客户图

NOTES:

- 1.FINISH:
 1.1 HOUSING: LCP BLACK,UL94V-0.
 1.2 CONTACT: COPPER ALLOY,
 GOLD 10u" PLATED IN CONTACT AERA,
 80u" MIN MATTE TIN PLATED OVER
 50u" MIN. NICKEL UNDERPLATED OVER ALL.
2. ELECTRICAL:
 2.1 RATED VOLTAGE: POWER PIN AC 575V
 POWER PIN DC 812V.
 2.2 CURRENT RATING: 2PC POWER PIN 28.8A.
 4PCS POWER PIN 24.7A.
 6PCS POWER PIN 24.1A.
 8PCS POWER PIN 22.3A.
- 3.OPERATION TEMPERATURE:-55°C TO +125°C.

62S1V-F XXX S4 075 C 01

Pin数码	端子电镀:	塑胶高度:	包装方式:
002=2PIN	S4=10u" Gold/Tin	075=7.58mm	C=TRAY
~	SN=TIN		
010=10PIN			

TABLE1:

No. OF PIN	A	B	C	D
002=2PIN	5.00	17.55	6.88	12.64
003=3PIN	10.00	22.55	11.88	17.64
004=4PIN	15.00	27.55	16.88	22.64
005=5PIN	20.00	32.55	21.88	27.64
006=6PIN	25.00	37.55	26.88	32.64
007=7PIN	30.00	42.55	31.88	37.64
008=8PIN	35.00	47.55	36.88	42.64
009=9PIN	40.00	52.55	41.88	47.64
010=10PIN	45.00	57.55	46.88	52.64

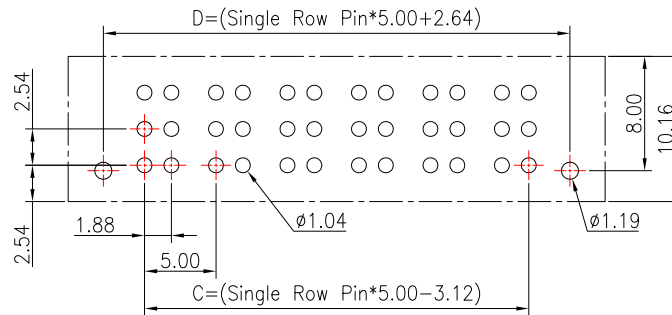
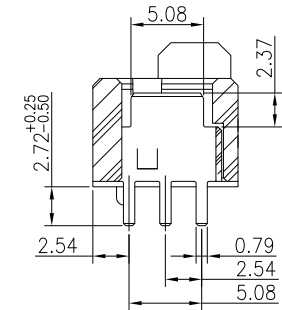
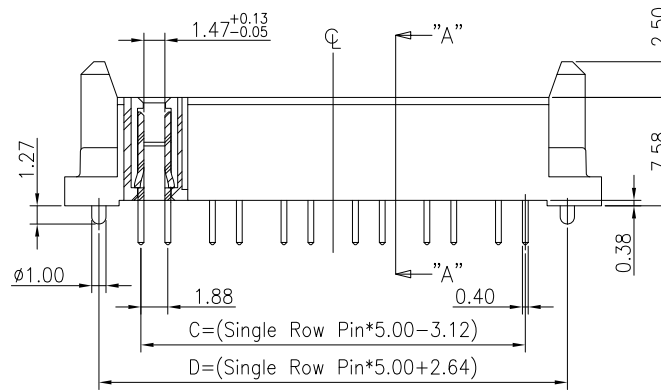
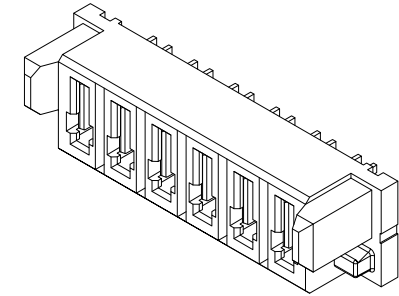
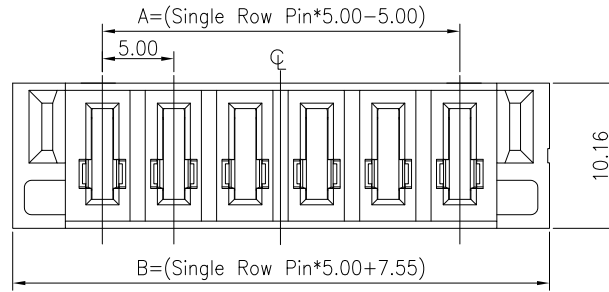

REV	DATE	MODIFICATION DESCRIPTION	CHANGE	APPROVE	OPERATION	DRAW	WLY	DATE	SOLEPIN 东莞市硕品电子有限公司 Professional connector manufacturer DONGGUAN SOLEPIN ELECTRONICS CO., LTD.				
					X.X	±0.40	DESIGN	Jensen	2021.12.25	SIZE	A4	PART NO.	62S1V-FXXXXX075C01
					X.XX	±0.25	CHECK	Jack	2021.12.25	SHEET	1/1	TITLE:	5.0mm 电源连接器 母座 DIP180° TYPE
AO		NEW			X.XXX	±0.15	APPROVE	Andy	2021.12.25	PROJ.		DRAW NO.	SP-690
					Angle	±3°				UNIT	mm	SCALE	1:1
					DIM.	TOL							

客户图

NOTES:

1. FINISH:
 1.1 HOUSING: LCP BLACK, UL94V-0.
 1.2 CONTACT: COPPER ALLOY,
 GOLD 10 μ m PLATED IN CONTACT AREA,
 80 μ m MIN MATTE TIN PLATED OVER
 50 μ m MIN. NICKEL UNDERPLATED OVER ALL.
2. ELECTRICAL:
 2.1 RATED VOLTAGE: POWER PIN AC 575V
 POWER PIN DC 812V.
 2.2 CURRENT RATING: 2PC POWER PIN 28.8A.
 4PCS POWER PIN 24.7A.
 6PCS POWER PIN 24.1A.
 8PCS POWER PIN 22.3A.
3. OPERATION TEMPERATURE: -55°C TO +125°C.

62S1V-M XXX S4 113 C 01

Pin 数码 端子电镀: 塑胶高度: 包装方式:
 002=2PIN S4=10 μ m Gold/Tin 113=11.38mm C=TRAY
 ~ SN=TIN

010=10PIN

TABLE 1:

No. OF PIN	A	B	C	D
002=2PIN	5.00	17.55	6.88	12.62
003=3PIN	10.00	22.55	11.88	17.62
004=4PIN	15.00	27.55	16.88	22.62
005=5PIN	20.00	32.55	21.88	27.62
006=6PIN	25.00	37.55	26.88	32.62
007=7PIN	30.00	42.55	31.88	37.62
008=8PIN	35.00	47.55	36.88	42.62
009=9PIN	40.00	52.55	41.88	47.62
010=10PIN	45.00	57.55	46.88	52.62

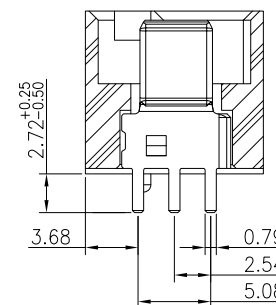
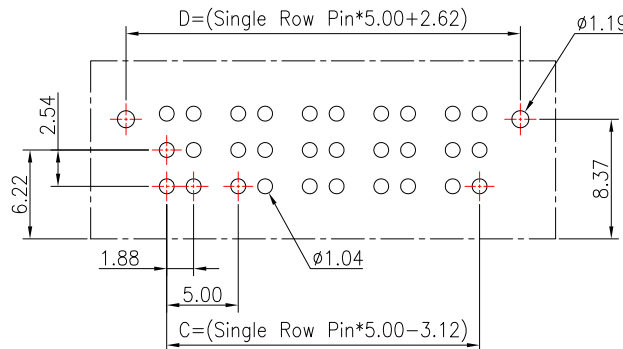
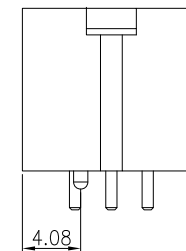
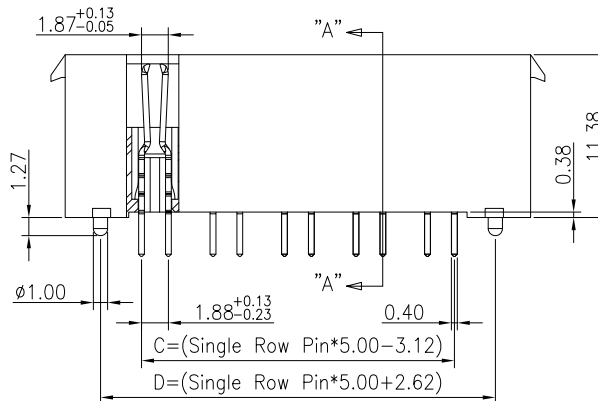
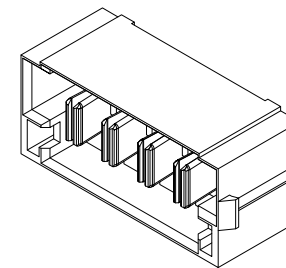
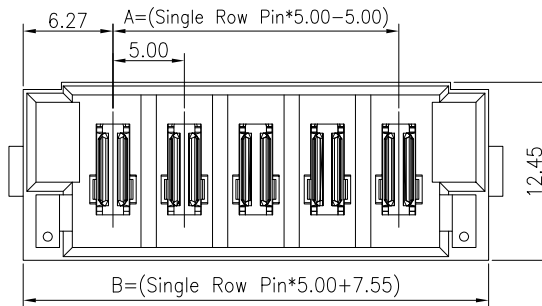

RECOMMENDED PCB LAYOUT
 PCB BOARD TOLERANCE ± 0.05

REV	DATE	MODIFICATION DESCRIPTION	CHANGE	APPROVE	OPERATION	DRAW	WLY	DATE	SOLEPIN 东莞市硕品电子有限公司 Professional connector manufacturer DONGGUAN SOLEPIN ELECTRONICS CO., LTD.				
					X.X	± 0.40	DESIGN	Jensen	2021.12.25	SIZE	A4	PART NO.	62S1V-MXXXXX113C01
					X.XX	± 0.25	CHECK	Jack	2021.12.25	SHEET	1/1	TITLE:	5.0mm 电源连接器 公头 DIP180° TYPE
AO		NEW			X.XXX	± 0.15	APPROVE	Andy	2021.12.25	PROJ.		DRAW NO.	SP-073
					Angle	$\pm 3^\circ$				UNIT	mm	SCALE	1:1
					DIM.	TOL							

客户图

NOTES:

- 1.FINISH:
 1.1 HOUSING: LCP BLACK,UL94V-0.
 1.2 CONTACT: COPPER ALLOY,
 GOLD 10u" PLATED IN CONTACT AREA,
 80u" MIN MATTE TIN PLATED OVER
 50u" MIN. NICKEL UNDERPLATED OVER ALL.

2. ELECTRICAL:

- 2.1 RATED VOLTAGE: POWER PIN AC 250V
 POWER PIN DC 354V.
 2.2 CURRENT RATING: 2PC POWER PIN 28.8A.
 4PCS POWER PIN 24.7A.
 6PCS POWER PIN 24.1A.
 8PCS POWER PIN 22.3A.

3.OPERATION TEMPERATURE:-55°C TO +125°C.

62S2-F XX XXX XX S4 101 C 01

电源Pin数	信号Pin数	电源Pin数	端子电镀:	塑胶高度:	包装方式:
01=1PIN	004=4*1PIN	01=1PIN	S4=10u"Gold/Tin	101=10.16mm	C=TRAY
02=2PIN	~	02=2PIN	SN=TIN		
03=3PIN	080=4*20PIN	03=3PIN			
04=4PIN	04=4PIN	04=4PIN			

TABLE1:

电源PIN数	信号PIN数	A	B	C	D
左右各1PIN	004=4*1PIN	20.17	8.88	NA	10.76
	008=4*2PIN	22.17	10.88	2.00	12.76
	012=4*3PIN	24.17	12.88	4.00	14.76
	016=4*4PIN	26.17	14.88	6.00	16.76
	020=4*5PIN	28.17	16.88	8.00	18.76
	024=4*6PIN	30.17	18.88	10.00	20.76
.....					
080=4*20PIN	58.17	46.88	38.00	48.76	
左右各2PIN	004=4*1PIN	30.17	18.88	NA	20.76
	008=4*2PIN	32.17	20.88	2.00	22.76
	012=4*3PIN	34.17	22.88	4.00	24.76
	016=4*4PIN	36.17	24.88	6.00	26.76
	020=4*5PIN	38.17	26.88	8.00	28.76
	024=4*6PIN	40.17	28.88	10.00	30.76
				
	080=4*20PIN	68.17	56.88	38.00	58.76

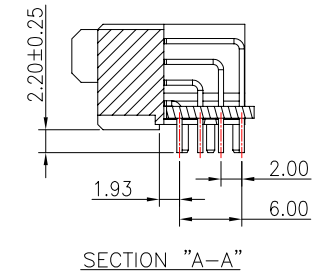
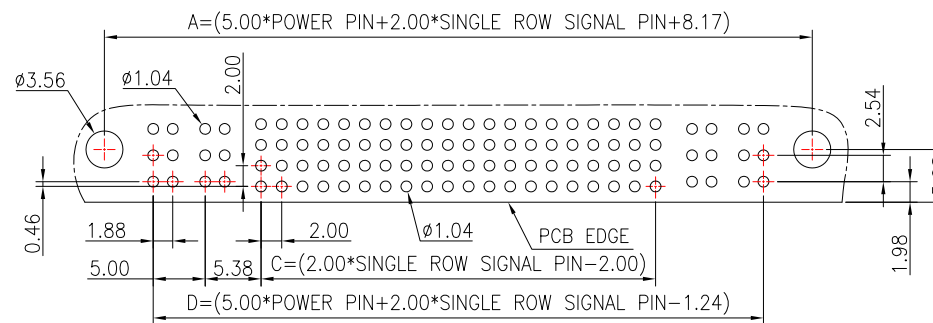
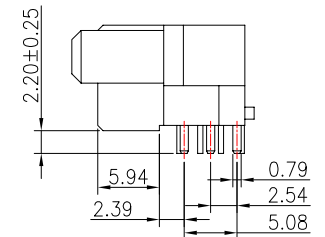
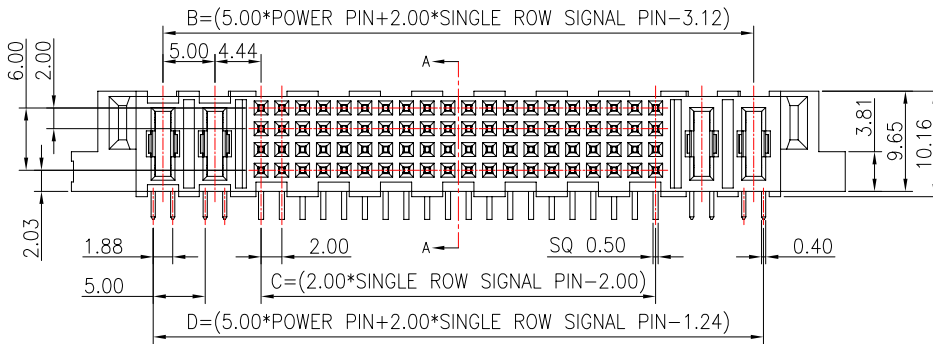
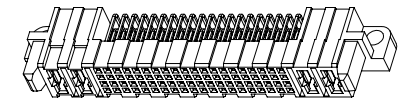
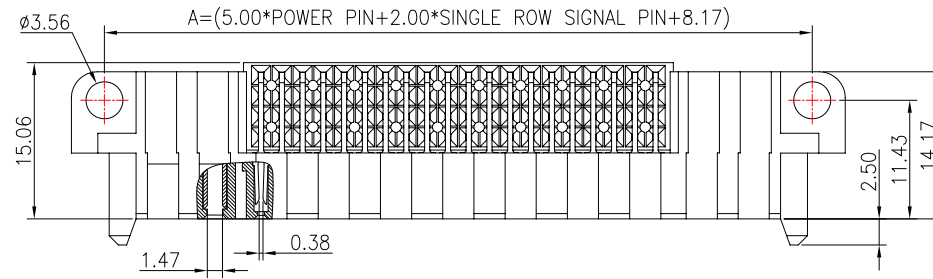

RECOMMENDED PCB LAYOUT
 PCB BOARD TOLERANCE±0.05

REV	DATE	MODIFICATION DESCRIPTION	CHANGE	APPROVE	OPERATION	DRAW	WLY	2021.12.25	SOLEPIN 东莞市硕品电子有限公司 Professional connector manufacturer DONGGUAN SOLEPIN ELECTRONICS CO., LTD.				
					X.X	±0.40	DESIGN	Jensen	2021.12.25	SIZE	A4	PART NO.	62S2-FXXXXXXXS4101C01
					X.XX	±0.25	CHECK	Jack	2021.12.25	SHEET	1/1	TITLE:	电源连接器 母座 5.0mm电源+2.0信号 DIP 90°
AO		NEW			X.XXX	±0.15	APPROVE	Andy	2021.12.25	PROJ.	PROJ.	DRAW NO.	SP-607
					Angle	±3°				UNIT	mm	SCALE	1:1
					DIM.	TOL							

客户图

- NOTES:
 1.FINISH:
 1.1 HOUSING: LCP BLACK,UL94V-0.
 1.2 CONTACT: COPPER ALLOY,
 GOLD 10u" PLATED IN CONTACT AREA,
 80u" MIN MATTE TIN PLATED OVER
 50u" MIN. NICKEL UNDERPLATED OVER ALL.
 2. ELECTRICAL:
 2.1 RATED VOLTAGE: POWER PIN AC 250V
 POWER PIN DC 354V.
 2.2 CURRENT RATING: 2PC POWER PIN 28.8A.
 4PCS POWER PIN 24.7A.
 6PCS POWER PIN 24.1A.
 8PCS POWER PIN 22.3A.
 3.OPERATION TEMPERATURE:-55°C TO +125°C.

62S2-M XX XXX XX S4 124 C 01

电源Pin数 信号Pin数 电源Pin数 端子电镀: 塑胶高度: 包装方式:
 01=1PIN 004=4*1PIN 01=1PIN S4=10u"Gold/Tin 124=12.45mm C=TRAY
 02=2PIN ~ 02=2PIN SN=TIN
 03=3PIN 080=4*20PIN 03=3PIN
 04=4PIN 04=4PIN

TABLE1:

电源PIN数	信号PIN数	A	B	C	D	E
左右各1PIN	004=4*1PIN	20.17	21.44	8.88	NA	10.76
	008=4*2PIN	22.17	23.44	10.88	2.00	12.76
	012=4*3PIN	24.17	25.44	12.88	4.00	14.76
	016=4*4PIN	26.17	27.44	14.88	6.00	16.76
	020=4*5PIN	28.17	29.44	16.88	8.00	18.76
	024=4*6PIN	30.17	31.44	18.88	10.00	20.76
.....
080=4*20PIN	58.17	59.44	46.88	38.00	48.76	
左右各2PIN	004=4*1PIN	30.17	31.44	18.88	NA	20.76
	008=4*2PIN	32.17	33.44	20.88	2.00	22.76
	012=4*3PIN	34.17	35.44	22.88	4.00	24.76
	016=4*4PIN	36.17	37.44	24.88	6.00	26.76
	020=4*5PIN	38.17	39.44	26.88	8.00	28.76
	024=4*6PIN	40.17	41.44	28.88	10.00	30.76
.....
080=4*20PIN	68.17	69.44	56.88	38.00	58.76	

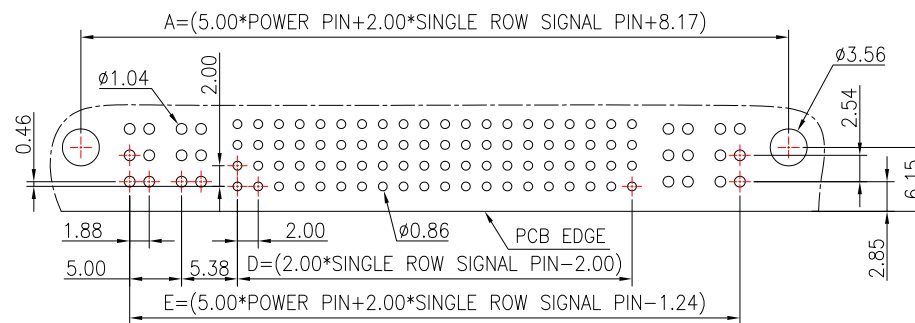
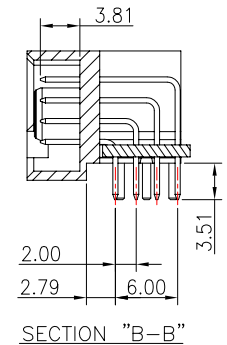
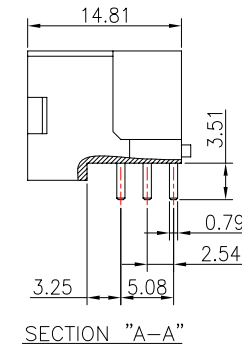
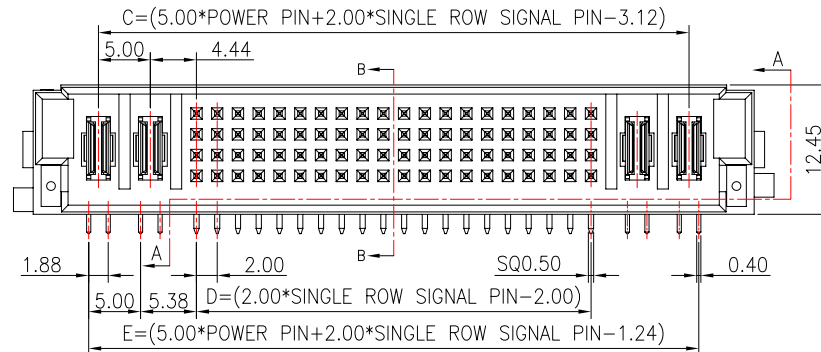
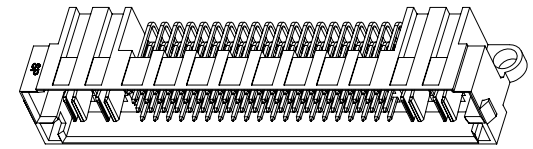
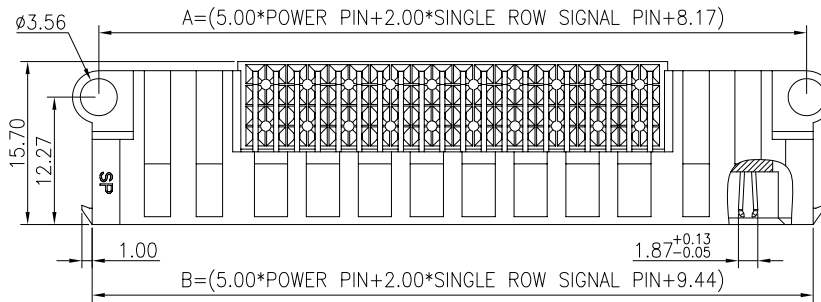

RECOMMENDED PCB LAYOUT
 PCB BOARD TOLERANCE ±0.05

REV	DATE	MODIFICATION DESCRIPTION	CHANGE	APPROVE	OPERATION	DRAW	WLY	DATE	SOLEPIN 东莞市硕品电子有限公司 Professional connector manufacturer DONGGUAN SOLEPIN ELECTRONICS CO., LTD.				
					X.X ±0.40	DESIGN	Jensen	2021.12.25	SIZE	A4	PART NO.	62S2-MXXXXXXXS4124C01	
					X.XX ±0.25	CHECK	Jack	2021.12.25	SHEET	1/1	TITLE:	电源连接器 公头 5.0mm电源+2.0信号 DIP 90°	
AO		NEW			X.XXX ±0.15	APPROVE	Andy	2021.12.25	PROJ.	PROJ.	DRAW NO.	SP-607	
					Angle ±3°				UNIT	mm	SCALE	1:1	
					DIM. TOL								

客户图

NOTES:

- 1.FINISH:
 1.1 HOUSING: LCP BLACK,UL94V-0.
 1.2 CONTACT: COPPER ALLOY,
 GOLD 10u" PLATED IN CONTACT AREA,
 80u" MIN MATTE TIN PLATED OVER
 50u" MIN. NICKEL UNDERPLATED OVER ALL.

2. ELECTRICAL:

- 2.1 RATED VOLTAGE: POWER PIN AC 250V
 POWER PIN DC 354V.
 2.2 CURRENT RATING: 2PC POWER PIN 28.8A.
 4PCS POWER PIN 24.7A.
 6PCS POWER PIN 24.1A.
 8PCS POWER PIN 22.3A.

3.OPERATION TEMPERATURE:-55°C TO +125°C.

62S2V-F XX XXX XX S4 075 C 01

电源Pin数 信号Pin数 电源Pin数 端子电镀: 塑胶高度: 包装方式:
 01=1PIN 004=4*1PIN 01=1PIN S4=10u"Gold/Tin 075=7.58mm C=TRAY
 02=2PIN ~ 02=2PIN SN=TIN
 03=3PIN 080=4*20PIN 03=3PIN
 04=4PIN 04=4PIN

TABLE1:

电源PIN数	信号PIN数	A	B	C	D	E
左右各1PIN	004=4*1PIN	21.44	8.88	NA	10.76	16.51
	008=4*2PIN	23.44	10.88	2.00	12.76	18.51
	012=4*3PIN	25.44	12.88	4.00	14.76	20.51
	016=4*4PIN	27.44	14.88	6.00	16.76	22.51
	020=4*5PIN	29.44	16.88	8.00	18.76	24.51
	024=4*6PIN	31.44	18.88	10.00	20.76	26.51
					
080=4*20PIN	59.44	46.88	38.00	48.76	54.51	
左右各2PIN	004=4*1PIN	31.44	18.88	NA	20.76	26.51
	008=4*2PIN	33.44	20.88	2.00	22.76	28.51
	012=4*3PIN	35.44	22.88	4.00	24.76	30.51
	016=4*4PIN	37.44	24.88	6.00	26.76	32.51
	020=4*5PIN	39.44	26.88	8.00	28.76	34.51
	024=4*6PIN	41.44	28.88	10.00	30.76	36.51
					
080=4*20PIN	69.44	56.88	38.00	58.76	64.51	

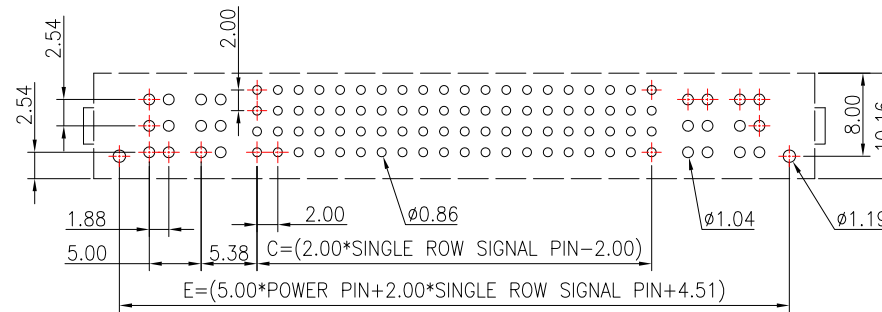
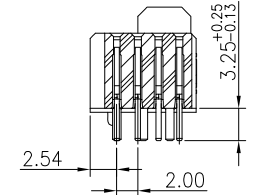
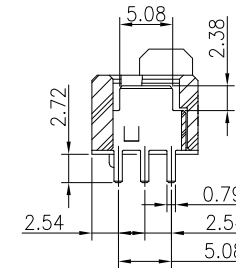
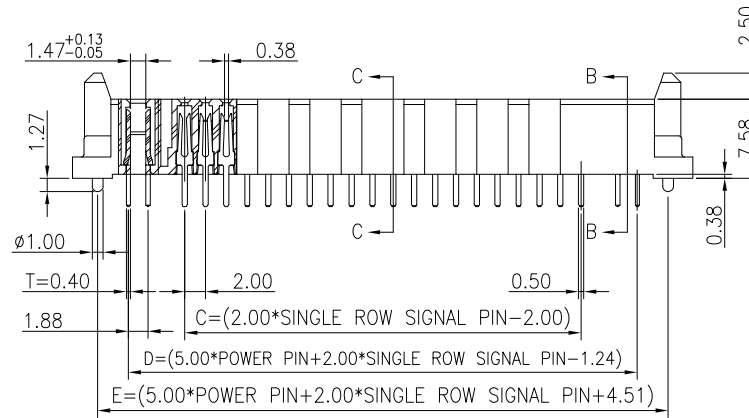
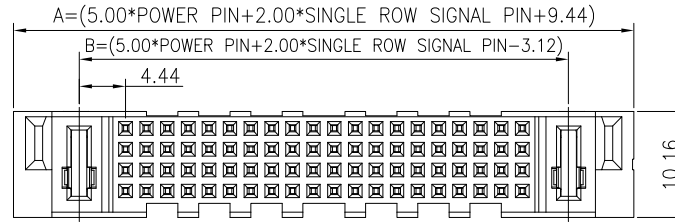

RECOMMENDED PCB LAYOUT
 PCB BOARD TOLERANCE±0.05

REV	DATE	MODIFICATION DESCRIPTION	CHANGE	APPROVE	OPERATION	DRAW	WLY	SCALE	UNIT	mm	SCALE	1:1	PROJ.	PROJ.	DRAW NO.	SP-608
AO		NEW			X.X ±0.40	DESIGN	Jensen	2021.12.25								
					X.XX ±0.25	CHECK	Jack	2021.12.25								
					X.XXX ±0.15	APPROVE	Andy	2021.12.25								
					Angle ±3°											
					DIM. TOL											

SOLEPIN 东莞市硕品电子有限公司
 Professional connector manufacturer DONGGUAN SOLEPIN ELECTRONICS CO., LTD.

SIZE A4 PART NO. 62S2V-FXXXXXXXXS4075C01
 SHEET 1/1 TITLE: 电源连接器 母座 5.0mm电源+2.0信号 DIP 180°
 PROJ. DRAW NO. SP-608

客户图

NOTES:

- 1.FINISH:
 1.1 HOUSING: LCP BLACK,UL94V-0.
 1.2 CONTACT: COPPER ALLOY,
 GOLD 10u" PLATED IN CONTACT AREA,
 80u" MIN MATTE TIN PLATED OVER
 50u" MIN. NICKEL UNDERPLATED OVER ALL.
2. ELECTRICAL:
 2.1 RATED VOLTAGE: POWER PIN AC 250V
 POWER PIN DC 354V.
 2.2 CURRENT RATING: 2PC POWER PIN 28.8A.
 4PCS POWER PIN 24.7A.
 6PCS POWER PIN 24.1A.
 8PCS POWER PIN 22.3A.
- 3.OPERATION TEMPERATURE:-55°C TO +125°C.

62S2V-M XX XXX XX S4 113 C 01

电源Pin数 信号Pin数 电源Pin数 端子电镀: 塑胶高度: 包装方式:
 01=1PIN 004=4*1PIN 01=1PIN S4=10u"Gold/Tin 113=11.38mm C=TRAY
 02=2PIN ~ 02=2PIN SN=TIN
 03=3PIN 080=4*20PIN 03=3PIN
 04=4PIN 04=4PIN

TABLE1:

电源PIN数	信号PIN数	A	B	C	D	E
左右各1PIN	004=4*1PIN	21.44	8.88	NA	10.76	16.51
	008=4*2PIN	23.44	10.88	2.00	12.76	18.51
	012=4*3PIN	25.44	12.88	4.00	14.76	20.51
	016=4*4PIN	27.44	14.88	6.00	16.76	22.51
	020=4*5PIN	29.44	16.88	8.00	18.76	24.51
	024=4*6PIN	31.44	18.88	10.00	20.76	26.51
.....						
	080=4*20PIN	59.44	46.88	38.00	48.76	54.51
左右各2PIN	004=4*1PIN	31.44	18.88	NA	20.76	26.51
	008=4*2PIN	33.44	20.88	2.00	22.76	28.51
	012=4*3PIN	35.44	22.88	4.00	24.76	30.51
	016=4*4PIN	37.44	24.88	6.00	26.76	32.51
	020=4*5PIN	39.44	26.88	8.00	28.76	34.51
	024=4*6PIN	41.44	28.88	10.00	30.76	36.51
.....						
	080=4*20PIN	69.44	56.88	38.00	58.76	64.51

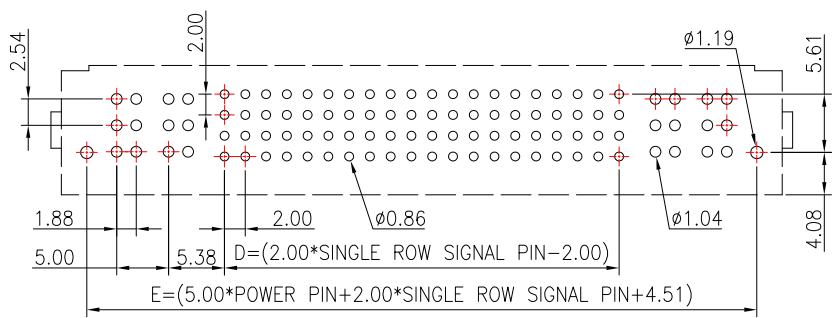
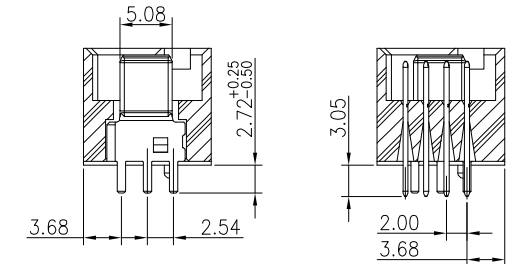
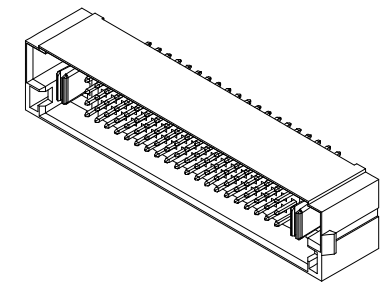
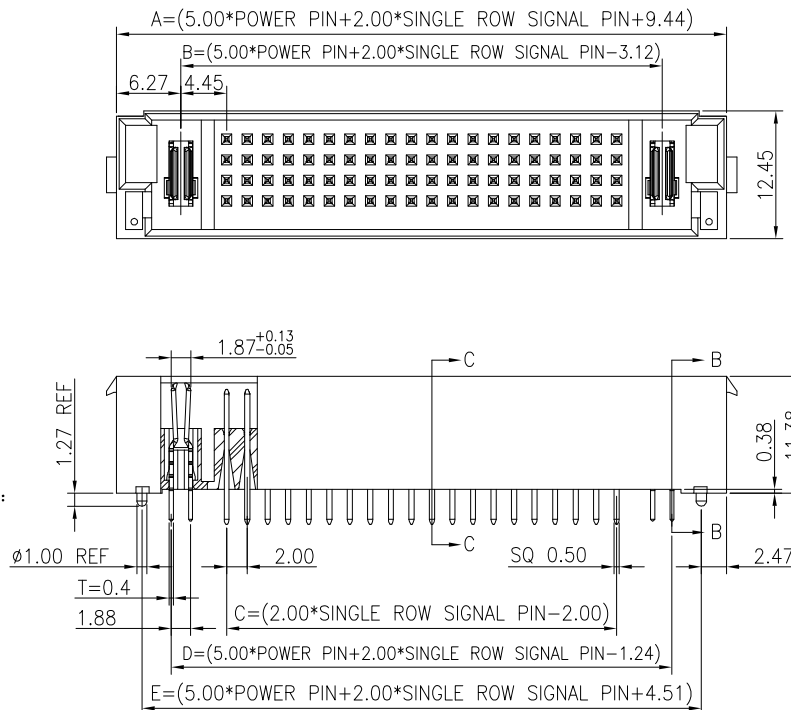

					OPERATION	DRAW	WLY	2021.12.25	SOLEPIN 东莞市硕品电子有限公司 Professional connector manufacturer DONGGUAN SOLEPIN ELECTRONICS CO., LTD.					
					X.X ±0.40	DESIGN	Jensen	2021.12.25						
					X.XX ±0.25	CHECK	Jack	2021.12.25	SIZE	A4	PART NO.	62S2V-MXXXXXXXXS4113C01		
AO			NEW		X.XXX ±0.15	APPROVE	Andy	2021.12.25	SHEET	1/1	TITLE:	电源连接器 公头 5.0mm电源+2.0信号 DIP 180°		
REV	DATE	MODIFICATION DESCRIPTION		CHANGE	APPROVE	DIM.	TOL	UNIT	mm	SCALE	1:1	PROJ.	DRAW NO.	SP-607