

客户图

NOTES:

1. FINISH:
 - 1.1 HOUSING: LCP BLACK,UL94V-0.
 - 1.2 CONTACT: PHOSPHOR BRONZE ,GOLD (SEE P/N) PLATED IN CONTACT AERA, 80u" MIN MATTE TIN PLATED IN SOLDER AREA,50u" MIN. NICKEL UNDERPLATED OVERALL.
2. ELECTRICAL:
 - 2.1 CURRENT RATING:3A;
 - 2.2 DIELECTRIC WITHSTANDING VOLTAGE: 500V AC/MINUTE.
 - 2.3 CONTACT RESISTANCE: 30mΩ MAX.
 - 2.4 INSULATION RESISTANCE: 1000MΩ MIN.
 - 2.5 OPERATION TEMPERATURE:-40°C TO +105°C.
3. ORDER INFORMATION:

61C1- XXX XX 078 C 01

Pin数码	端子电镀:	塑胶高度:	包装方式:
010=2x5PIN	S1=1u" Gold/Tin	078=7.8mm	C=TRAY
.....	S2=3u" Gold/Tin		
200=2x100PIN	S3=5u" Gold/Tin		
	S4=10u" Gold/Tin		
	S5=15u" Gold/Tin		
	S6=30u" Gold/Tin		

TABLE1:

No. OF PIN	A	B	C	D
010:2x5PIN	3.20	5.40	8.60	6.20
020:2x10PIN	7.20	9.40	12.60	10.20
030:2x15PIN	11.20	13.40	16.60	14.20
040:2x20PIN	15.20	17.40	20.60	18.20
050:2x25PIN	19.20	21.40	24.60	22.20
060:2x30PIN	23.20	25.40	28.60	26.20
080:2x40PIN	31.20	33.40	36.60	34.20
100:2x50PIN	39.20	41.40	44.60	42.20
120:2x60PIN	47.20	49.40	52.60	50.20
150:2x75PIN	59.20	61.40	64.60	62.20
200:2x100PIN	79.20	81.40	84.60	82.20

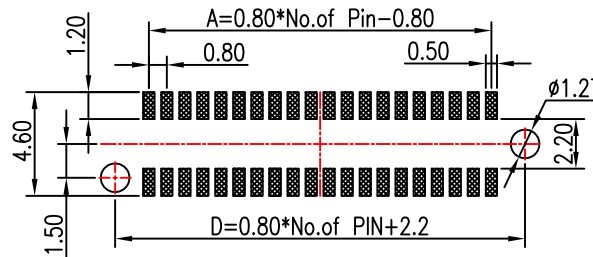
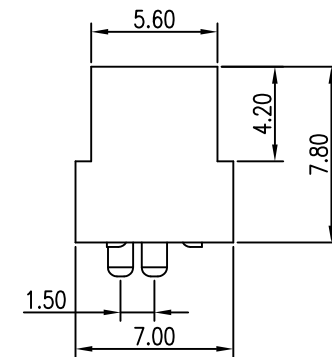
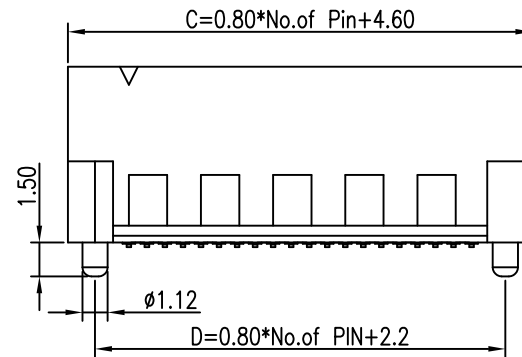
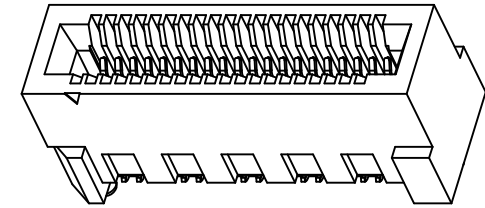
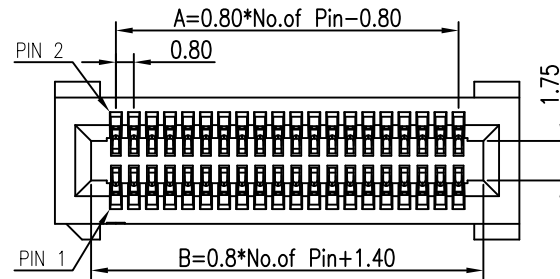

RECOMMENDED PCB LAYOUT(TOP SIDE)
PCB BOARD TOLFRANCF±0.05

OPERATION		DRAW	WLY	2021.03.01
X.X	±0.40	DESIGN	Jensen	2021.03.01
X.XX	±0.25	CHECK	Jack	2021.03.01
X.XXX	±0.15	APPROVE	Andy	2021.03.01
Angle	±3°	UNIT	mm	SCALE 1:1
DIM.	TOL	UNIT	mm	SCALE 1:1

SOLEPIN 东莞市硕品电子有限公司
Professional connector manufacturer DONGGUAN SOLEPIN ELECTRONICS CO., LTD.

REV	DATE	MODIFICATION DESCRIPTION	CHANGE	APPROVE	SIZE	A4	PART NO.	61C1-XXXXX078C01
AO		NEW			SHEET	1/2	TITLE:	0.80mm 金手指 180° SMT CONNECTOR L形焊脚
					PROJ.	☞	DRAW NO.	SP-227

客户图

NOTES:

1. FINISH:
 - 1.1 HOUSING: LCP BLACK,UL94V-0.
 - 1.2 CONTACT: PHOSPHOR BRONZE ,GOLD (SEE P/N) PLATED IN CONTACT AERA, 80u" MIN MATTE TIN PLATED IN SOLDER AREA,50u" MIN. NICKEL UNDERPLATED OVERALL.
2. ELECTRICAL:
 - 2.1 CURRENT RATING:3A;
 - 2.2 DIELECTRIC WITHSTANDING VOLTAGE: 500V AC/MINUTE.
 - 2.3 CONTACT RESISTANCE: 30mΩ MAX.
 - 2.4 INSULATION RESISTANCE: 1000MΩ MIN.
 - 2.5 OPERATION TEMPERATURE:-40°C TO +105°C.

3.ORDER INFORMATION:

61C1 - XXX XX 078 C 03 - XX

Pin数码	端子电镀:	塑胶高度:	包装方式:	"B"SPACES PIN数:
010=2x5PIN	S1=1u" Gold/Tin	078=7.8mm	C=TRAY	01=2x1PIN
.....	S2=3u" Gold/Tin		
200=2x100PIN	S3=5u" Gold/Tin			50=2x50PIN
	S4=10u" Gold/Tin			
	S5=15u" Gold/Tin			
	S6=30u" Gold/Tin			

TABLE1:

No. OF PIN	A	B	C	D	E	F	G
026:2x13PIN	12.80	5	3.20	5.30	15.00	18.20	15.80
030:2x15PIN	14.40	5	3.20	5.30	16.60	19.80	17.40
050:2x25PIN	22.40	5	3.20	5.30	24.60	27.80	25.40
074:2x37PIN	32.00	20	15.20	17.30	34.20	37.40	35.00
080:2x40PIN	34.40	21	16.00	18.10	36.60	39.80	37.40
098:2x49PIN	41.60	26	20.00	22.10	43.80	47.00	44.60
100:2x50PIN	42.40	26	20.00	22.10	44.60	47.80	45.40
120:2x60PIN	50.40	31	24.00	26.10	52.60	55.80	53.40
140:2x70PIN	58.40	31	24.00	26.10	60.60	63.80	61.40
160:2x80PIN	66.40	31	24.00	26.10	68.60	71.80	69.40
180:2x90PIN	74.40	31	24.00	26.10	76.60	79.80	77.40
200:2x100PIN	82.40	31	24.00	26.10	84.60	87.80	85.40
200:2x100PIN	82.40	50	39.20	41.30	84.60	87.80	85.40

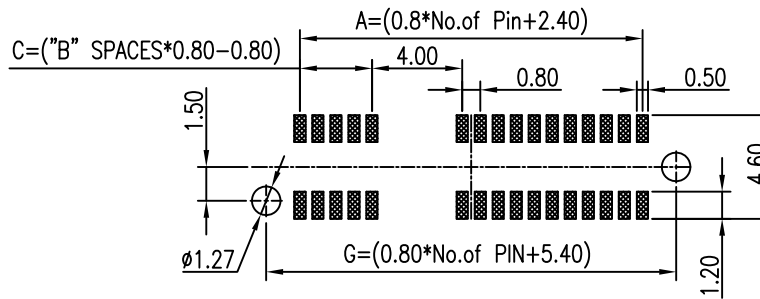
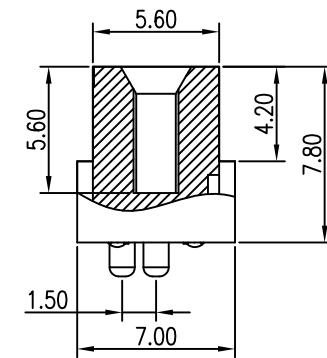
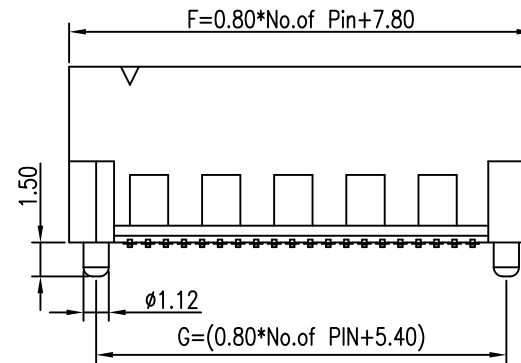
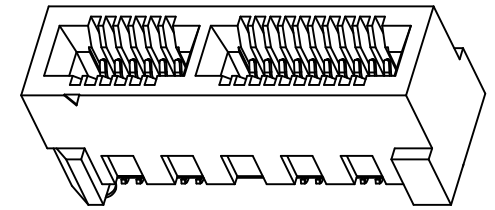
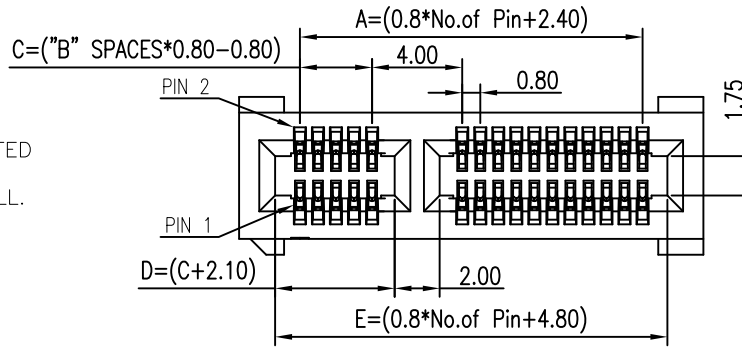

RECOMMENDED PCB LAYOUT(TOP SIDE)
PCB BOARD TOLFRANCF±0.05

OPERATION		DRAW	WLY	2021.03.01
X.X	±0.40	DESIGN	Jensen	2021.03.01
X.XX	±0.25	CHECK	Jack	2021.03.01
X.XXX	±0.15	APPROVE	Andy	2021.03.01
Angle	±3°	UNIT	mm	SCALE 1:1
DIM.	TOL	UNIT	mm	SCALE 1:1

SOLEPIN 东莞市硕品电子有限公司
Professional connector manufacturer DONGGUAN SOLEPIN ELECTRONICS CO., LTD.

REV	DATE	MODIFICATION DESCRIPTION	CHANGE	APPROVE
AO		NEW		

SIZE	A4	PART NO.	61C1-XXXXX078C03-XX
SHEET	1/1	TITLE:	0.80mm 金手指 180° SMT 带隔栏 C形焊脚
PROJ.	☞	DRAW NO.	SP-441